

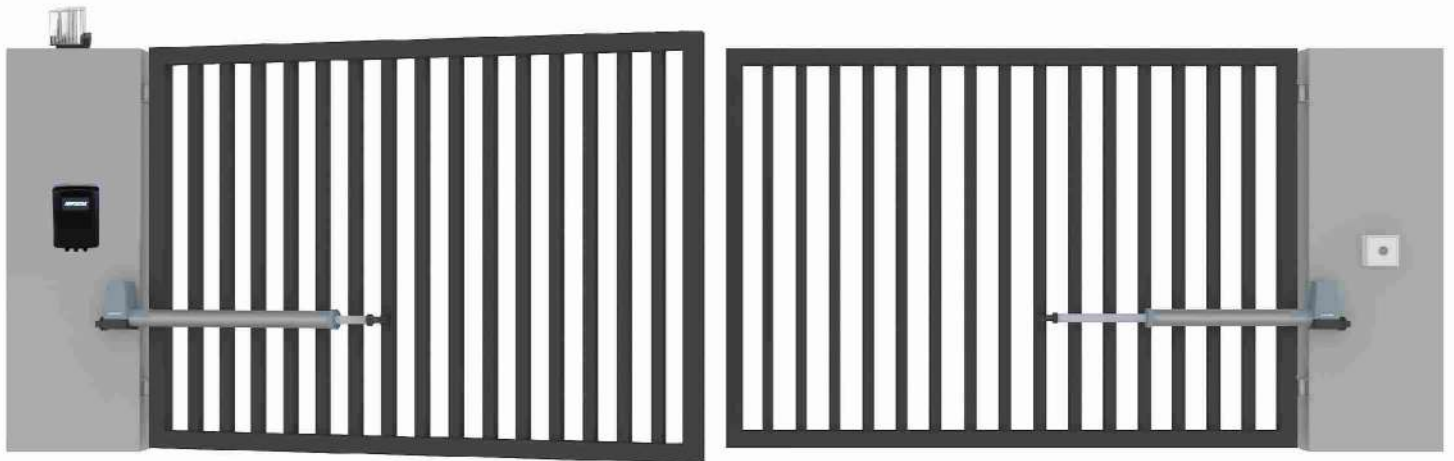

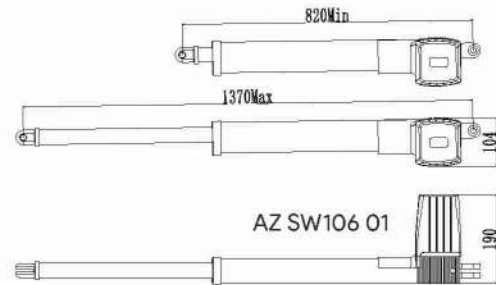

## SWING GATE OPERATOR AZSW106 02 / AZSW106 01

# AUTOZON®

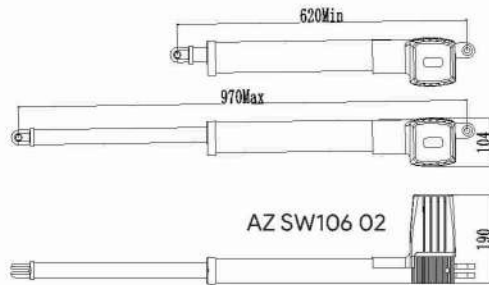

### PRODUCT DESCRIPTION:

- o The swing gate operator is applicable for all gates with the weight of the single-leaf gate up to 300 kg and the width of each swing gate should be 2.5m/3m
- o The drive mode adopts the worm and worm gear to combine the screw rod transmission.
- o Microprocessor control unit with a wide variety of setting options, such as pedestrian leaf function, automatic closing of the gate, etc.
- o Operator can be manually unlocked in any position (e.g. in the event of a power failure)
- o Soft start and Soft stop
- o Connections for safety devices, such as warning light and photocell as well as for an external device (DC 24 V), potential-free relay contact
- o Fast installation and also provided with easy electrical connection



# SWING GATE OPERATOR AZSW106 02 / AZSW106 01

# AUTOZON®

## RECOMMENDED ACCESSORIES:



AZ T21W  
Transmitter



AZ T22  
Transmitter



AZ PC 10  
Photocell



AZ PCW L11  
Wireless Photocell



AZ KS 15  
Key Switch



AZ WLKP 17  
Wireless Keypad



AZ FL 19  
Flash Lamp



AZ RF WIFI 31 A  
Wifi Module



AZ GSM 30  
GSM Module



AZ EL32  
Electronic Lock



AZ SLSP 319  
Solar Kit



AZ CSVC 217  
Car Sun Visor Clip

## GATE HARDWARE:



Hinges with  
Bearing



Pivot Hinges with  
Roller Bearing



Adjustable Gate Hinges  
with Round plate



Bi Folding  
Bearing Hinges



Rotating Bearing  
Wheel



Gate Stopper  
for Two Leaf Gate



Gate  
Stopper

## OPTIONAL INTEGRATION:



FACE  
RECOGNITION



FINGER  
PRINT



RFID



QR CODE



PASSWORD



IOT



GSM



SAFETY  
DEVICES



BATTERY  
BACKUP

## TECHNICAL SPECIFICATIONS:

AZSW106 02

AZSW106 01

Power supply	220 V - 240 V AC	220 V - 240 V AC
Motor power	80 W * 2 nos	80 W * 2 nos
Motor Voltage	24 V DC	24 V DC
Maximum weight of gate	300+ 300 Kg	300+ 300 Kg
Maximum leaf length	2.5 M + 2.5 M	3 M + 3 M
Maximum piston stroke	340 mm	540 mm
Maximum force	1500 N	1500 N
Opening time	18° / s ~ 22° / s	18° / s ~ 22° / s
Remote control distance	≥ 30 m	≥ 30 m
Max Recording of Transmitter	25 nos	25 nos
Working Duty	S2, 30 min	S2, 30 min
Working temperature	-20°C ~ +70°C	-20°C ~ +70°C
Protection Class	IP 54	IP 54
Product Weight	17 Kg	19 Kg

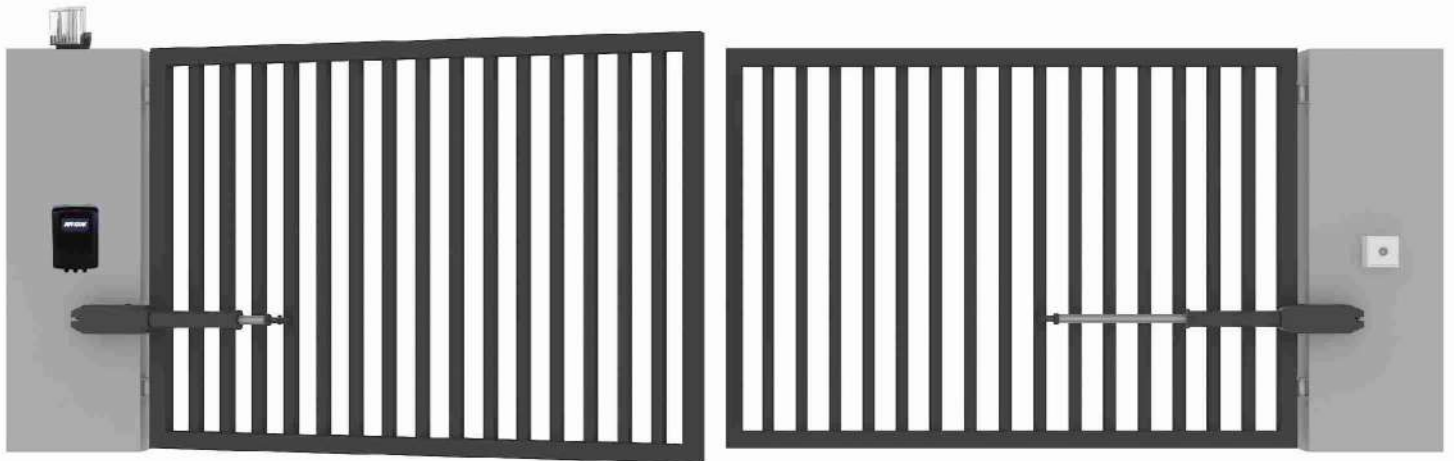
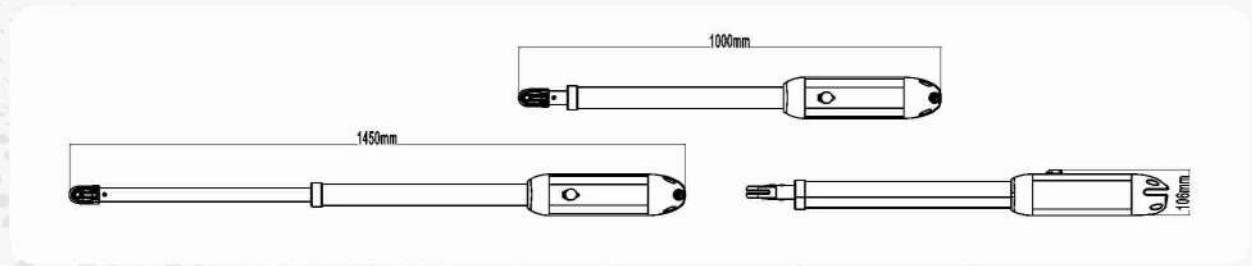

**PRODUCT DESCRIPTION:**

- o The swing gate piston operator is applicable for operation of gates with the weight of the single-leaf gate up to 400 kg and the width of each swing gate shorter than 3m.
- o Ideal operator for swing and bi folding gate
- o Integrated magnetic limit to open and close the gate
- o The operator can be used for the left or right gate
- o Microprocessor control unit with a wide variety of setting options, such as pedestrian leaf function, automatic closing of the gate, etc.
- o Operator can be manually unlocked in any position (e.g. in the event of a power failure)
- o Connections for safety devices, such as warning light and photocell, as well as for an external device (DC 24 V), relay contact without potential
- o Fast installation and also provided with easy electrical connection

**RECOMMENDED ACCESSORIES:**



AZ T21W  
Transmitter



AZ T22  
Transmitter



AZ PC 10  
Photocell



AZ PCW L11  
Wireless Photocell



AZ KS 15  
Key Switch



AZ WLKP 17  
Wireless Keypad



AZ FL 19  
Flash Lamp



AZ RF WIFI 31 A  
Wifi Module



AZ GSM 30  
GSM Module



AZ EL32  
Electronic Lock



AZ SLSP 319  
Solar Kit



AZ CSVC 217  
Car Sun Visor Clip

**GATE HARDWARE:**



Hinges with  
Bearing



Pivot Hinges with  
Roller Bearing



Adjustable Gate Hinges  
with Round plate



Bi Folding  
Bearing Hinges



Rotating Bearing  
Wheel



Gate Stopper  
for Two Leaf Gate



Gate  
Stopper

**OPTIONAL INTEGRATION:**



FACE  
RECOGNITION



FINGER  
PRINT



RFID



QR CODE



PASSWORD



IOT



GSM



SAFETY  
DEVICES



BATTERY  
BACKUP

**TECHNICAL SPECIFICATIONS:**

**AZSW110**

Power supply	220 V - 240 V AC
Motor power	62 W * 2 nos
Motor Voltage	24 V DC
Maximum weight of gate	400+ 400 Kg
Maximum leaf length	3 M + 3 M
Maximum piston stroke	450 mm
Maximum force	2500 N
Gate Moving Speed	22 ~26 s / 90°
Remote control distance	≥ 30 m
Max Recording of Transmitter	32
Working Duty	S2, 30 min
Working temperature	-20°C ~ +70°C
Protection Class	IP 54
Product Weight	20 Kg

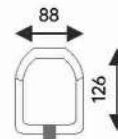
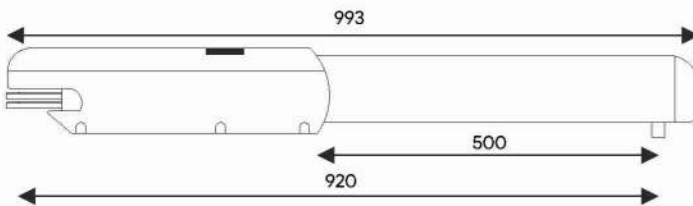
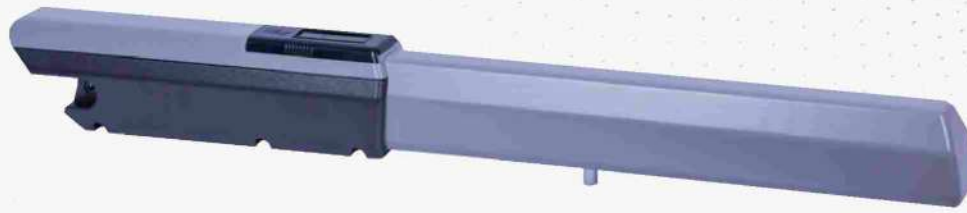

Gate width and weight:

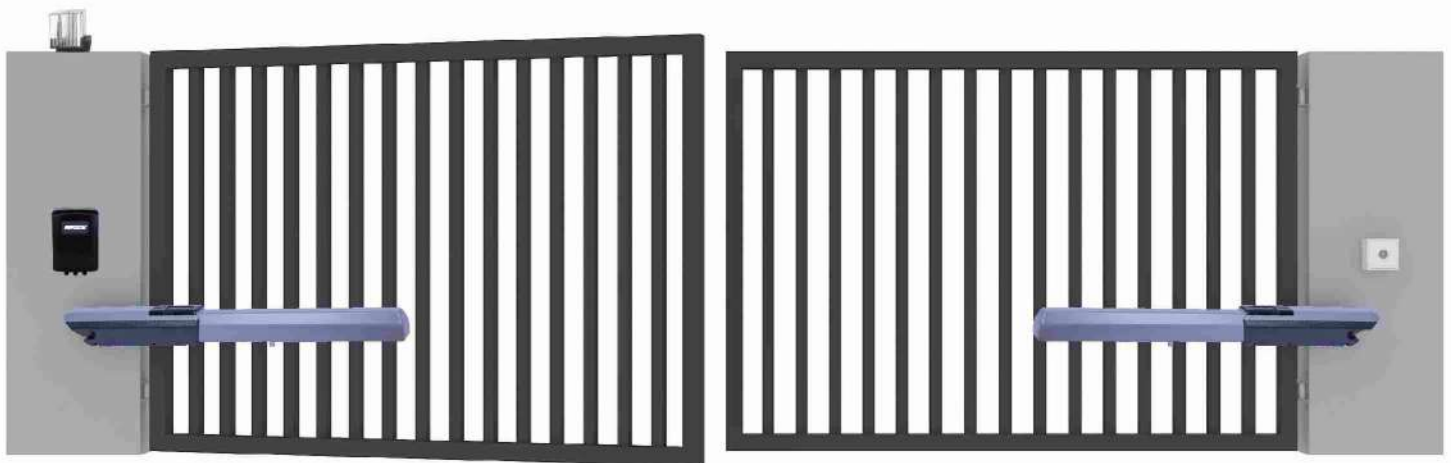
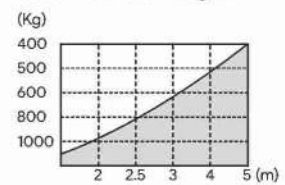

### PRODUCT DESCRIPTION:

- o AZ SW112 Swing Gate Operator is applicable for operation of gates with the weight of single leaf gate up to 400 kg and width up to 5 m.
- o The lead screw with high steel strength has improved the kinematic characteristics; telescopic lever system; smooth ride, etc.,
- o Integrated micro switch limit to open and close the gate
- o The operator can be used for the left or right gate
- o Microprocessor control unit with a wide variety of setting options, such as pedestrian leaf function, automatic closing of the gate, etc.
- o Operator can be manually unlocked in any position (e.g. in the event of a power failure)
- o Connections for safety devices, such as warning light and photocell, as well as for an external device (DC 24 V), relay contact without potential
- o Fast installation and also provided with easy electrical connection



# SWING GATE OPERATOR AZSW112

# AUTOZON®

## RECOMMENDED ACCESSORIES:



AZ T21W  
Transmitter



AZ T22  
Transmitter



AZ PC 10  
Photocell



AZ PCW L11  
Wireless Photocell



AZ RFPC 417M  
IP Reflector Photocell



AZ KS 15  
Key Switch



AZ WLKP 17  
Wireless Keypad



AZ FL 19  
Flash Lamp



AZ RF WIFI 31 A  
Wifi Module



AZ GSM 30  
GSM Module



AZ EL32  
Electronic Lock



AZ CSVK 217  
Car Sun Visor Clip

## GATE HARDWARE:



Hinges with  
Bearing



Pivot Hinges with  
Roller Bearing



Adjustable Gate Hinges  
with Round plate



Bi Folding  
Bearing Hinges



Rotating Bearing  
Wheel

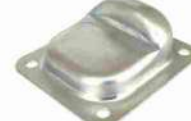

Gate Stopper  
for Two Leaf Gate



Gate  
Stopper

## OPTIONAL INTEGRATION:



FACE  
RECOGNITION



FINGER  
PRINT



RFID



QR CODE



PASSWORD



IOT



GSM



SAFETY  
DEVICES

## TECHNICAL SPECIFICATIONS:

### AZSW112

Power supply	220 V - 240 V AC
Motor power	150 W * 2 nos
Motor Voltage	230 V AC
Maximum weight of Single Leaf Gate	400 - 1000 Kg
Maximum length of Single Leaf Gate	2 - 5 M
Maximum piston stroke	500 mm
Maximum force	3000 N
Traveling Time	17 s
Remote control distance	≥ 30 m
Max Recording of Transmitter	40
Working Duty	S4
Working temperature	-20°C ~ +70°C
Protection Class	IP 54
Product Weight	30 Kg

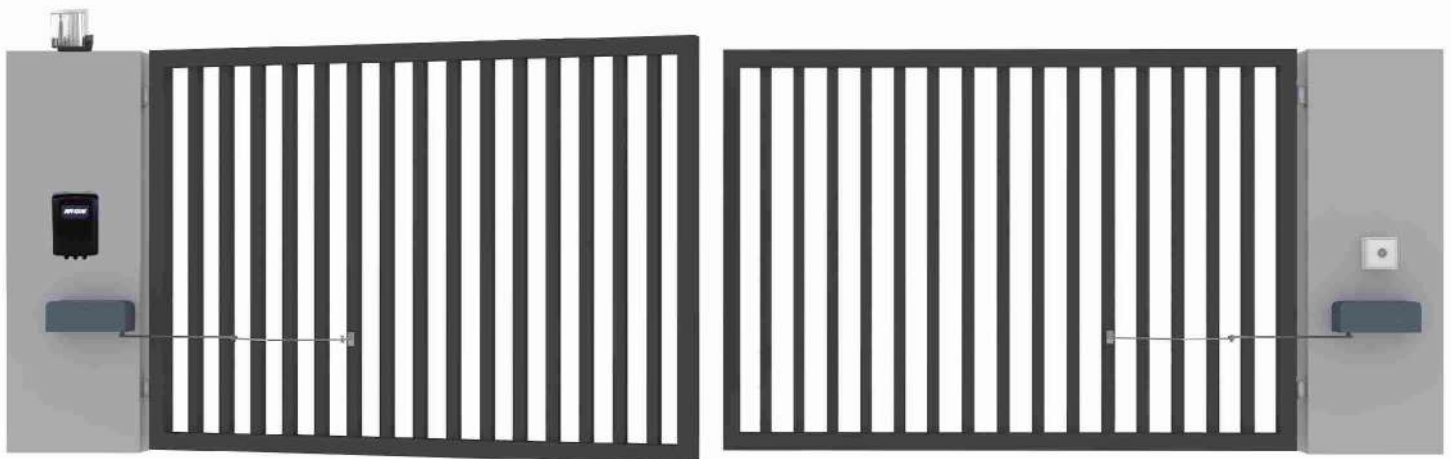
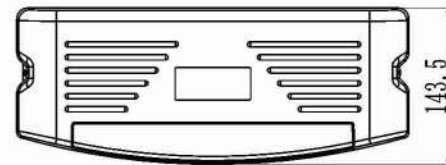
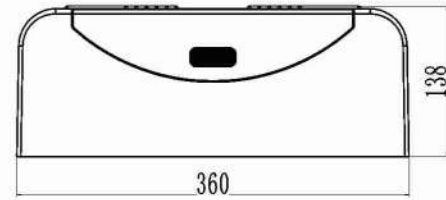

### PRODUCT DESCRIPTION:

- o The swing gate articulated operator is applicable for operation of gates with the weight of single-leaf gate up to 400 kg and the width of each swing gate shorter than 4 m.
- o The drive mode adopts the worm and worm gear to combine the pinion transmission.
- o Integrated mechanical limit for open and close position
- o Microprocessor control unit with a wide variety of setting options, such as pedestrian leaf function, automatic closing of the gate, etc.
- o Operator can be manually unlocked in any position (e.g. in the event of a power failure)
- o Connections for safety devices, such as warning light and photocell, as well as for an external device (DC 24 V), relay contact without potential
- o Fast installation and also provided with easy electrical connection





# SWING GATE OPERATOR AZSW107 01

## RECOMMENDED ACCESSORIES:



AZ T21W  
Transmitter



AZ T22  
Transmitter



AZ PC 10  
Photocell



AZ PCW L11  
Wireless Photocell



AZ RFPC 417M  
IP Reflector Photocell



AZ KS 15  
Key Switch



AZ WLKP 17  
Wireless Keypad



AZ FL 19  
Flash Lamp



AZ RF WIFI 31 A  
Wifi Module



AZ GSM 30  
GSM Module



AZ EL32  
Electronic Lock



AZ CSVC 217  
Car Sun Visor Clip

## GATE HARDWARE:



Hinges with  
Bearing



Pivot Hinges with  
Roller Bearing



Adjustable Gate Hinges  
with Round plate



Bi Folding  
Bearing Hinges



Rotating Bearing  
Wheel



Gate Stopper  
for Two Leaf Gate



Gate  
Stopper

## OPTIONAL INTEGRATION:



FACE  
RECOGNITION



FINGER  
PRINT



RFID



QR CODE



PASSWORD



IOT



GSM



SAFETY  
DEVICES

## TECHNICAL SPECIFICATIONS:

AZSW107 01

Power supply	220 V - 240 V AC
Motor power	260 W * 2 nos
Motor Voltage	230 V AC
Maximum weight of gate	400+ 400 Kg
Maximum leaf length	3 M + 3 M
Gate Moving Speed	9° / s ~ 11° / s
Remote control distance	≥ 30 m
Max Recording of Transmitter	25 nos
Working Duty	S2, 15 min
Working temperature	-20°C ~ +70°C
Protection Class	IP 54
Product Weight	25.7 Kg

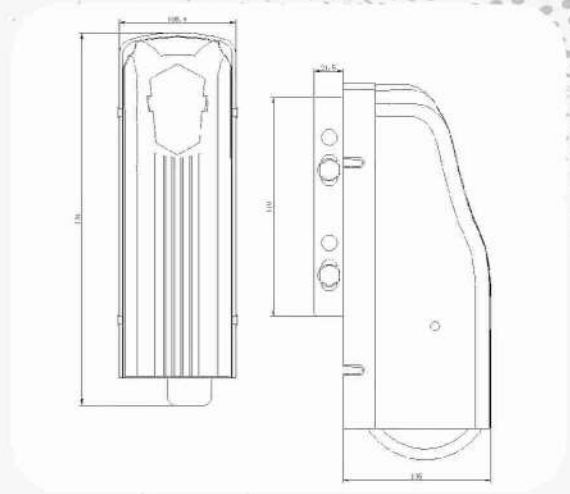

**PRODUCT DESCRIPTION:**

- o Easier to drive the gate : The motor is mounted on the far end from the hinge point
- o Special sliding groove : This enables to increase the tolerance capacity against the unevenness of road surface up to 100 mm.
- o Unlimited opening angle : As far as the opener is concerned, the opening angle can be greater than 180 degree.
- o Automatic locking : This combines both closing and locking actions.
- o Microprocessor control unit with a wide variety of setting options, such as pedestrian leaf function, automatic closing of the gate, etc.
- o Operator can be manually unlocked in any position
- o Connections for safety devices, such as warning light and photocell as well as for an external device (DC 24 V), potential-free relay contact
- o Fast installation and also provided with easy electrical connection



# SWING GATE OPERATOR AZSW108R 01

# AUTOZON®

## RECOMMENDED ACCESSORIES:



AZ T21W  
Transmitter



AZ T22  
Transmitter



AZ PC 10  
Photocell



AZ PCW L11  
Wireless Photocell



AZ RFPC 417M  
IP Reflector Photocell



AZ KS 15  
Key Switch



AZ WLKP 17  
Wireless Keypad



AZ WIFI 31 A  
Wifi Module



AZ GSM 30  
GSM Module



AZ FL 19  
Flash Lamp



AZ SLSP 319  
Solar Kit



AZ CSVC 217  
Car Sun Visor Clip

## GATE HARDWARE:



Hinges with  
Bearing



Pivot Hinges with  
Roller Bearing



Adjustable Gate Hinges  
with Round plate



Bi Folding  
Bearing Hinges



Rotating Bearing  
Wheel



Gate Stopper  
for Two Leaf Gate



Gate  
Stopper

## OPTIONAL INTEGRATION:



FACE  
RECOGNITION



FINGER  
PRINT



RFID



QR CODE



PASSWORD



IOT



GSM



SAFETY  
DEVICES



BATTERY  
BACKUP

## TECHNICAL SPECIFICATIONS:

AZSW108R 01

Power supply	220 V - 240 V AC
Motor power	100 W * 2 nos
Motor Voltage	24 V DC
Maximum weight of gate	600+ 600 Kg
Motor Force	1000 N
RPM	2800
Gate Moving Speed	10° / s ~ 15° / s
Remote control distance	≥ 30 m
Max Recording of Transmitter	25 nos
Working Duty	S1
Working temperature	-20°C ~ +70°C
Protection Class	IP 54
Product Weight	17 Kg

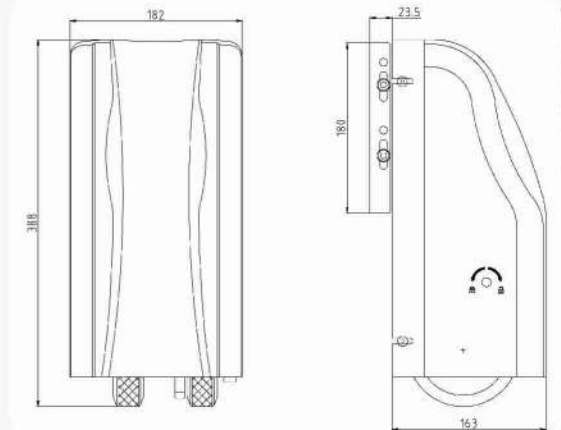

**PRODUCT DESCRIPTION:**

- o Swing Roller gate operator is designed to move gates installed in heavy industrial and commercial buildings
- o Easier to drive the gate : The motor is mounted on the far end from the hinge point
- o Spring enhances the tolerance capacity against the uneven surface of the road up to 70 mm.
- o Unlimited opening angle : As far as the opener is concerned, the opening angle can be greater than 180 degree.
- o Automatic locking : This combines both closing and locking actions.
- o Microprocessor control unit with a wide variety of setting options, such as pedestrian leaf function, automatic closing of the gate, etc.
- o Operator can be manually unlocked in any position
- o Connections for safety devices, such as warning light and photocell as well as for an external device (DC 24 V), potential-free relay contact

**RECOMMENDED ACCESSORIES:**



AZ T21W  
Transmitter



AZ T22  
Transmitter



AZ PC 10  
Photocell



AZ PCW L11  
Wireless Photocell



AZ RFPC 417M  
IP Reflector Photocell



AZ KS 15  
Key Switch



AZ WLKP 17  
Wireless Keypad



AZ RF WIFI 31 A  
Wifi Module



AZ GSM 30  
GSM Module



AZ FL 19  
Flash Lamp



AZ PB 16 A  
Push Button



AZ CSVC 217  
Car Sun Visor Clip

**GATE HARDWARE:**



Hinges with  
Bearing



Pivot Hinges with  
Roller Bearing



Adjustable Gate Hinges  
with Round plate



Bi Folding  
Bearing Hinges



Rotating Bearing  
Wheel

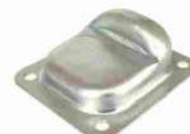

Gate Stopper  
for Two Leaf Gate



Gate  
Stopper

**OPTIONAL INTEGRATION:**



FACE  
RECOGNITION



FINGER  
PRINT



RFID



QR CODE



PASSWORD



IOT



GSM



SAFETY  
DEVICES



BATTERY  
BACKUP

**TECHNICAL SPECIFICATIONS:**

AZSW109R

Power supply	220 V - 240 V AC
Motor power	150 W * 2 nos
Motor Voltage	24 V DC
Maximum weight of gate	1000 + 1000 Kg
Motor Force	1500 N
RPM	2800
Gate Moving Speed	10° / s ~ 15° / s
Remote control distance	≥ 30 m
Max Recording of Transmitter	40
Working Duty	S1
Working temperature	-20°C ~ +70°C
Protection Class	IP 54
Product Weight	36 Kg

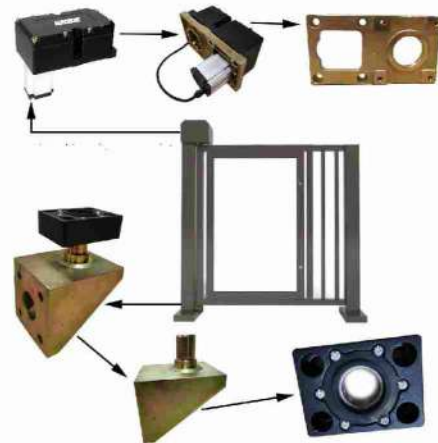
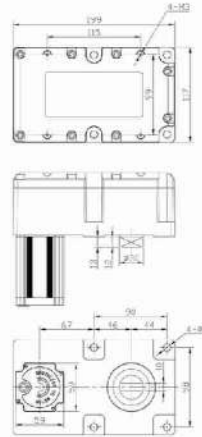

**PRODUCT DESCRIPTION:**

- o The pedestrian gate operator is a new type of advertising gate, which is mainly used for pedestrian passages and entrances, internal passages of the community, commercial, industry and other places where regulating the flow of people is a necessity
- o Automatic rebound function in opening and closing
- o Brush less motor for high performance and Noiseless operation.
- o Small size and large force
- o Intelligent circuit protection

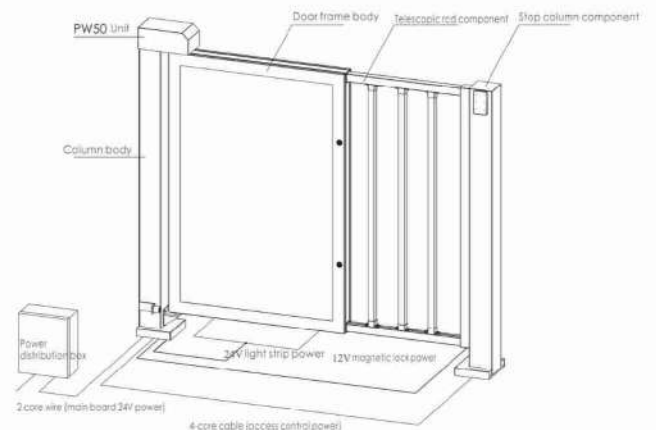



**RECOMMENDED ACCESSORIES:**



Transmitter



AZ PC 10  
Photocell



AZ RFPC 43  
Reflector Photocell



AZ SLD TLS 73  
Wired Touch  
less Sensor



AZ PB 16 A  
Push Button



AZ WIFI 31 A  
Wifi Module



AZ GSM 30  
GSM Module



AZ FL 19  
Flash Lamp



AZ SW EL 235  
Magnetic Lock



AZ PGOR 757  
Receiver

**PEDESTRIAN GATE HARDWARE:**

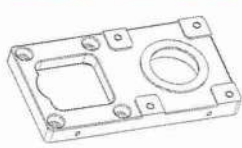

Motor Base

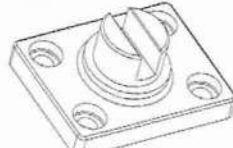

Motor Clamp

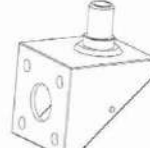

Base Clamp

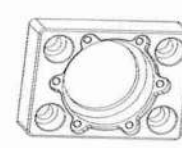

Bearing



Oil Seal

**OPTIONAL INTEGRATION:**



FACE  
RECOGNITION



FINGER  
PRINT



RFID



QR CODE



PASSWORD



IOT



GSM



SAFETY  
DEVICES



BATTERY  
BACKUP

**TECHNICAL SPECIFICATIONS:**

**AZSW111PGO**

Power supply	220 V - 240 V AC
Motor power	30 W
Motor Voltage	24 V BL DC
Current	1.5 A
Maximum weight of gate	75 Kg
RPM	1500
Gate Moving Speed	3° / s ~ 6° / s
Remote control distance	≥ 30 m
Max Recording of Transmitter	20
Working Duty	S1
Operating Cycle	≥ 5 Million
Working temperature	-30°C ~ +70°C
Protection Class	IP 54
Package Weight	5.18 Kg

# AUTOZON<sup>®</sup>

## ENTRANCE AUTOMATION

### Our Range of Products:



SLIDING GATE OPERATOR



SWING GATE OPERATOR



SLIDING DOOR OPERATOR



SWING DOOR OPERATOR



CURTAIN OPERATOR



BLINDS OPERATOR



BOOM BARRIER



GARAGE DOOR & OPERATOR



ROLLING SHUTTER & OPERATOR



HIGH SPEED DOOR & OPERATOR



SECTIONAL DOOR & OPERATOR



RETRACTABLE GATE



BOLLARD



DOCK LEVELLER



GATE HARDWARES



ACCESSORIES

### Applications:



RESIDENTIAL



INSTITUTION



PUBLIC PARKING



HOSPITAL



HOTEL



MALL



BUSINESS CENTER



WAREHOUSE



INDUSTRY

### Corporate Office:

#308/1A, Rajeev Gandhi Road  
Ganapathy, Coimbatore - 641 006  
Tamil Nadu, INDIA

### Chennai Branch Office:

No.3/14, 1st Cross Street, 1st Main Road,  
Kalaimagal Nagar, Ekkatuthangal,  
Chennai - 600032, Tamil Nadu, INDIA

### Contact:

T : +91 75980 16000  
M : +91 97872 55518

### Contact:

T : 044 47100570  
M : +91 9994929764



### For more details:

Visit: [www.autozonind.com](http://www.autozonind.com) | Email: [info@autozonind.com](mailto:info@autozonind.com)

### Sales & Service Network

Andhra Pradesh, Arunachal Pradesh, Assam, Bihar, Chhattisgarh, Goa, Gujarat, Haryana, Himachal Pradesh, Jharkhand, Karnataka, Kerala, Madhya Pradesh, Maharashtra, Manipur, Meghalaya, Mizoram, Nagaland, Odisha, Punjab, Rajasthan, Sikkim, Tamil Nadu, Telangana, Tripura, Uttar Pradesh, Uttarakhand, West Bengal



follow us on: [f](#) autozonind [@](#) autozonind [t](#) autozonind [c](#) autozonind