

SWING DOOR OPERATOR

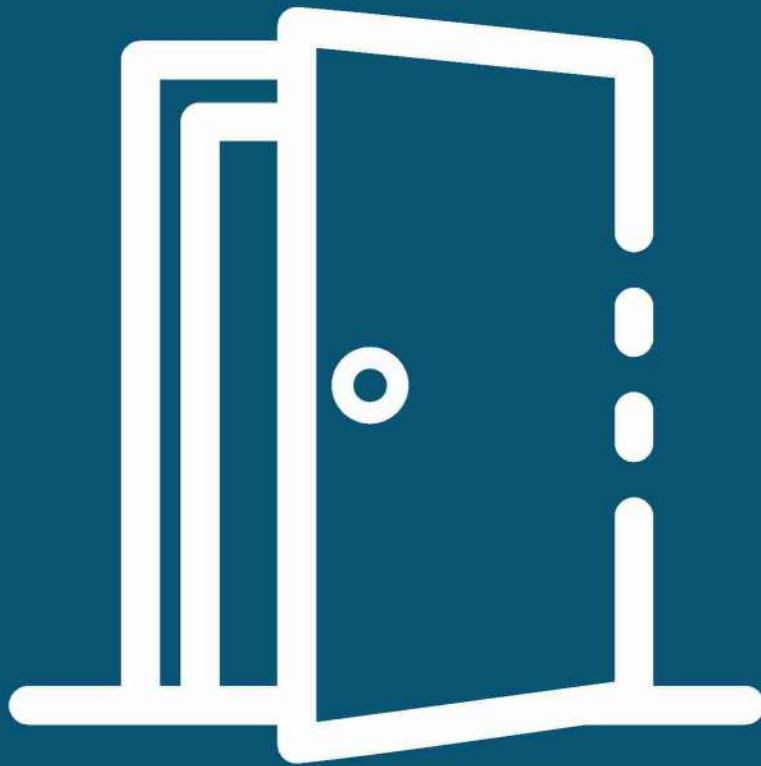



SWING DOOR OPERATOR AZSWD202

AUTOZON®

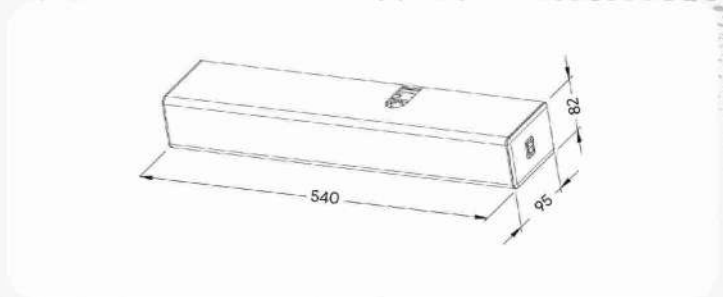

Door width and weight:

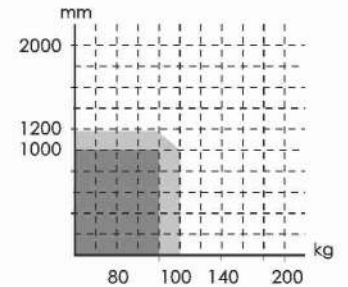

PRODUCT DESCRIPTION:

- o The Swing Door Operator drive unit operates with less noise, with reliable performance and safety, providing more convenience for living and working environments.
- o The Swing Door Operator is a new upgraded transformer-less drive that offers a wider range of supply power voltages. Provides interfaces such as sensors, access control, and security sensor protection, and is equipped with interfaces for magnetic electric lock and backup battery too.
- o UPS power can be configured to meet security requirements.
- o Both can realize Interlocking function between doors.
- o If touch obstacles or personnel in operation are encountered, the door will open in the opposite direction.
- o Applicable to office buildings, storefronts, banks, factories, restaurants, hotels, shopping centres, laboratories, hospitals and other places



SWING DOOR OPERATOR AZSWD202

AUTOZON®

RECOMMENDED ACCESSORIES:



AZ MRS 68
Microwave Sensor



AZ OMS 68 01
Microwave Sensor



AZ SWD KS 430
Keyswitch



AZ SWDSS 95
Safety Sensor



AZ SLD EX 72
Transmitter & Receiver



AZ SLD TLS 73
Wired Touchless Sensor



AZ SLD WLTS 74
Wireless Touchless Sensor



AZ SLD PB WL 70 A
Wireless Push Button & Receiver



AZ FS 92
Foot Sensor



AZ RF WIFI 31 A
Wifi Module

DOOR LEAF OPEN TOWARD INSIDE

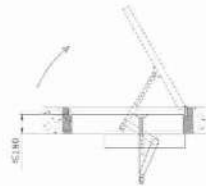
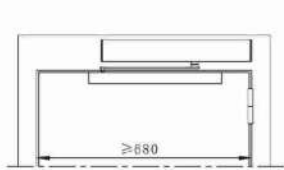

DOOR LEAF OPEN TOWARD OUTSIDE

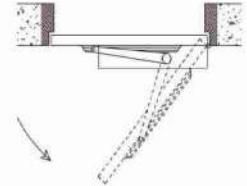
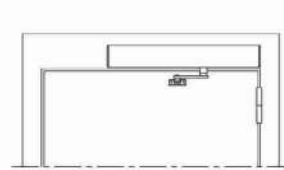

OPTIONAL INTEGRATION:



FACE
RECOGNITION



FINGER
PRINT



RFID



QR CODE



PASSWORD



IOT



TOUCHLESS
SENSOR



SAFETY
DEVICES



BATTERY
BACKUP

TECHNICAL SPECIFICATIONS:

AZSWD202

Door type	Single Door
Carrying weight	≤ 1 × 100 kg
Applicable door width	≤ 1200 mm
Power supply voltage	220 V - 240 V AC
Motor Power	24 V BL DC / 65 W
Opening time	3-7 s / 90° (adjustable)
Open time	1-30 s (adjustable)
Protection level	IP 12 D
Working temperature	-20 ~ +55°C
Product size (unit)	540 x 95 x 82 mm
Product weight (unit)	6.5 Kg



SWING DOOR OPERATOR AZSWD202A

AUTOZON®

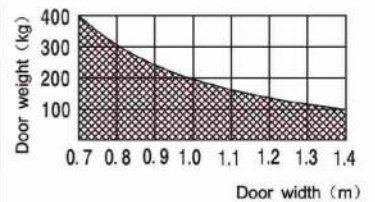
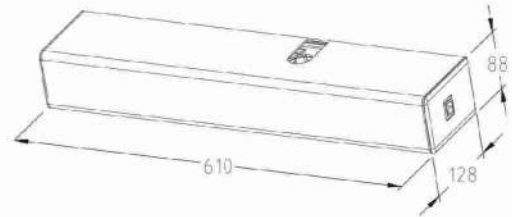

PRODUCT DESCRIPTION:

- o The Swing Door Operator drive unit operates with less noise, with reliable performance and safety, providing more convenience for living and working environments.
- o The Swing Door Operator is a new upgraded transformer-less drive that offers a wider range of supply power voltages. Provides interfaces such as sensors, access control, and security sensor protection, and is equipped with interfaces for magnetic electric lock and backup battery too.
- o UPS power can be configured to meet security requirements.
- o Both can realize Interlocking function between doors.
- o If touch obstacles or personnel in operation are encountered, the door will open in the opposite direction.
- o Applicable to office buildings, storefronts, banks, factories, restaurants, hotels, shopping centres, laboratories, hospitals and other places



SWING DOOR OPERATOR AZSWD202A

AUTOZON®

RECOMMENDED ACCESSORIES:



AZ MRS 68
Microwave Sensor



AZ OMS 68 01
Microwave Sensor

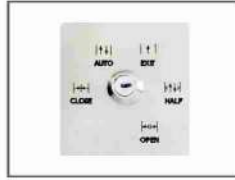

AZ SWD KS 430
Keyswitch



AZ SWDSS 95
Safety Sensor



AZ SLD EX 72
Transmitter & Receiver



AZ SLD TLS 73
Wired Touchless Sensor



AZ SLD WLTS 74
Wireless Touchless Sensor



AZ SLD PB WL 70 A
Wireless Push Button & Receiver



AZ FS 92
Foot Sensor



AZ RF WIFI 31 A
Wifi Module

DOOR LEAF OPEN TOWARD INSIDE

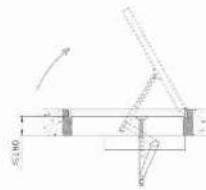
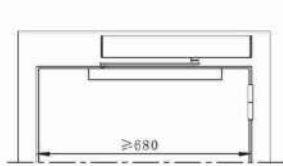

DOOR LEAF OPEN TOWARD OUTSIDE

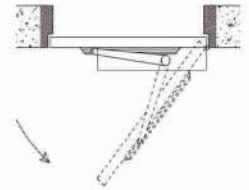
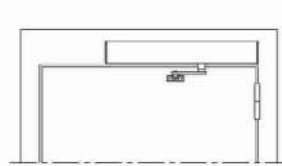

OPTIONAL INTEGRATION:



FACE
RECOGNITION



FINGER
PRINT



RFID



QR CODE



PASSWORD



IOT



TOUCH LESS
SENSOR



SAFETY
DEVICES



BATTERY
BACKUP

TECHNICAL SPECIFICATIONS:

AZSWD202A

Door type	Single Door
Carrying weight	≤ 1 × 200 kg
Applicable door width	≤ 1200 mm
Power supply voltage	220 V - 240 V AC
Motor Power	24 V BL DC / 100 W
Opening & Closing time (Speed)	3 - 7 s (adjustable)
Open Time	1 - 30 s (adjustable)
Open angle	80° - 100°
Protection level	IP 12 D
Working temperature	-20 ~ + 55°C
Product size (unit)	610 x 128 x 88 mm
Product weight (unit)	13 Kg



SWING DOOR OPERATOR AZSWD203UG

AUTOZON®

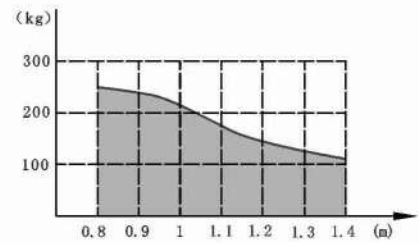
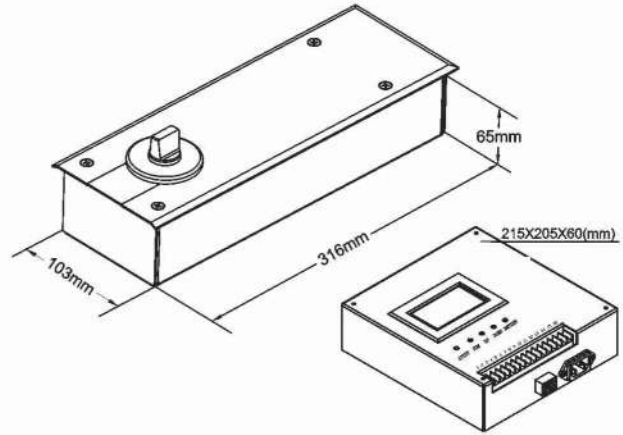
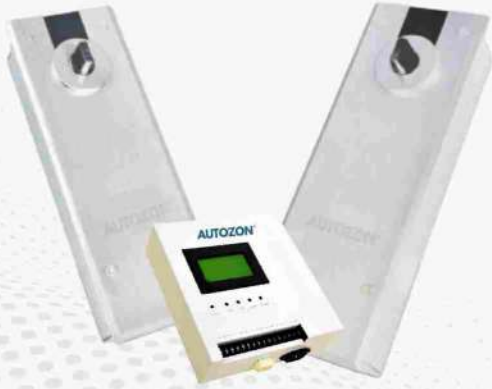

PRODUCT DESCRIPTION:

- o The controller has display debugging interface, which aids in easy operation and is equipped with function parts such as electric lock & backup battery.
- o The case of the machine is injection moulded by BMC. All DC motors are sealed to be super waterproof, fireproof and corrosion resistant.
- o The Max. load is 150KG, the unit can be opened at 90 degrees (automatically sense the passing direction of pedestrians, and opening the door with the pedestrian walking direction).
- o It is resistant to both low and high temperature and can work between the ranges of -20~ + 50°C environment.
- o Small size, waterproof, heavy load, easy construction, etc., can be used both indoor and outdoor.



SWING DOOR OPERATOR AZSWD203UG

AUTOZON®

RECOMMENDED ACCESSORIES:



AZ MRS 68
Microwave Sensor



AZ OMS 68 01
Microwave Sensor



AZ SLDRIS68 02
Microwave & Infrared Sensor



AZ SWDSS 95
Safety Sensor

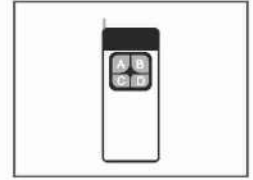

Remote



AZ SLD TLS 73
Wired Touchless Sensor



AZ SLD WLTS 74
Wireless Touchless Sensor



AZ SLD PB WL 70 A
Wireless Push Button & Receiver



AZ FS 92
Foot Sensor



AZ RF WIFI 31 A
Wifi Module

STANDARD COMPONENTS

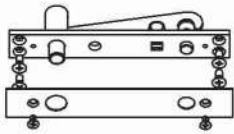

Top Brackets

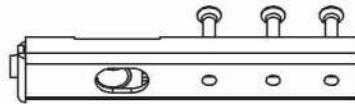

Bottom Brackets

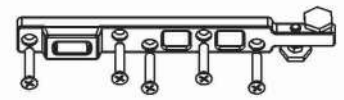

Rotating Arm

OPTIONAL INTEGRATION:



FACE
RECOGNITION



FINGER
PRINT



RFID



QR CODE



PASSWORD



IOT



TOUCHLESS
SENSOR



SAFETY
DEVICES



BATTERY
BACKUP

TECHNICAL SPECIFICATIONS:

AZSWD203UG

Power supply	220 V - 240 V AC
Motor power	24 V BL DC / 55 W
Max. door weight	150 kg
Max. door width	1200 mm
Max. torque	165 Nm
Running noise	<60 dB
Electric lock output	DC 12 V NO / NC
Opening /Closing time	6-12 s
Opening range	86°- 95°
Working temperature	-20 ~ +50°C
Protection level	IP68
Unit weight	5.5 Kg

AUTOZON®

ENTRANCE AUTOMATION

Our Range of Products:



SLIDING GATE OPERATOR



SWING GATE OPERATOR



SLIDING DOOR OPERATOR



SWING DOOR OPERATOR



CURTAIN OPERATOR



BLINDS OPERATOR



BOOM BARRIER



GARAGE DOOR & OPERATOR



ROLLING SHUTTER & OPERATOR



HIGH SPEED DOOR & OPERATOR



SECTIONAL DOOR & OPERATOR



RETRACTABLE GATE



BOLLARD



DOCK LEVELLER



GATE HARDWARES



ACCESSORIES

Applications:



RESIDENTIAL



INSTITUTION



PUBLIC PARKING



HOSPITAL



HOTEL



MALL



BUSINESS CENTER



WAREHOUSE



INDUSTRY

Corporate Office:

#308/1A, Rajeev Gandhi Road
Ganapathy, Coimbatore - 641 006
Tamil Nadu, INDIA

Chennai Branch Office:

No.3/14, 1st Cross Street, 1st Main Road,
Kalaimagal Nagar, Ekkatuthangal,
Chennai - 600032, Tamil Nadu, INDIA

Contact:

T : +91 75980 16000
M : +91 97872 55518

Contact:

T : 044 47100570
M : +91 9994929764



For more details:

Visit: www.autozonind.com | Email: info@autozonind.com

Sales & Service Network

Andhra Pradesh, Arunachal Pradesh, Assam, Bihar, Chhattisgarh, Goa, Gujarat, Haryana, Himachal Pradesh, Jharkhand, Karnataka, Kerala, Madhya Pradesh, Maharashtra, Manipur, Meghalaya, Mizoram, Nagaland, Odisha, Punjab, Rajasthan, Sikkim, Tamil Nadu, Telangana, Tripura, Uttar Pradesh, Uttarakhand, West Bengal



follow us on: [f](#) autozonind [@](#) autozonind [t](#) autozonind [c](#) autozonind